

ES5 · ESU5 · ES8N · ES10 · ES12N 型

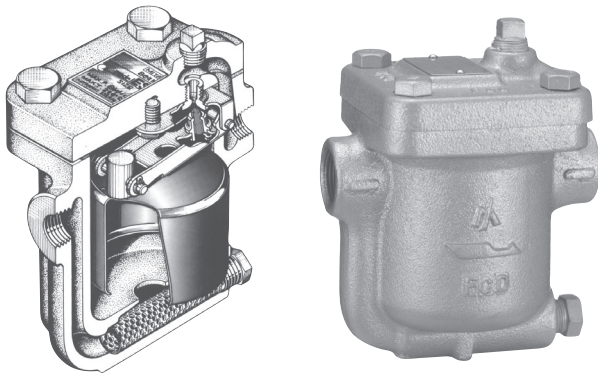

ES5 · ESU5-流量图

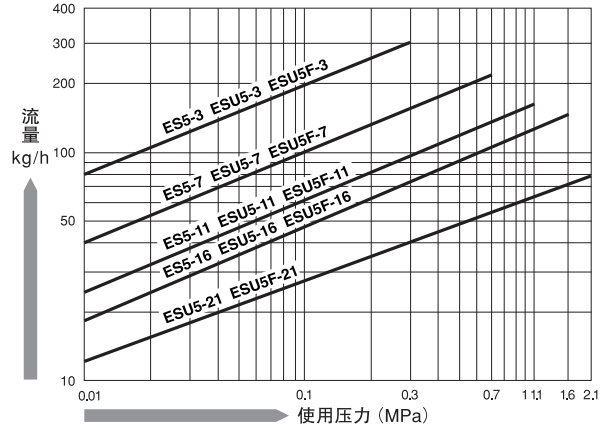

超长使用寿命SCCV®设计

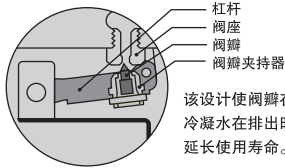

该设计使阀瓣在阀瓣夹持器内可以自由滑动以减轻冷凝水在排出时对其的冲击力及减少片面磨损有效延长使用寿命。

ES8N · ES8B · ES10 · ES12N-流量图

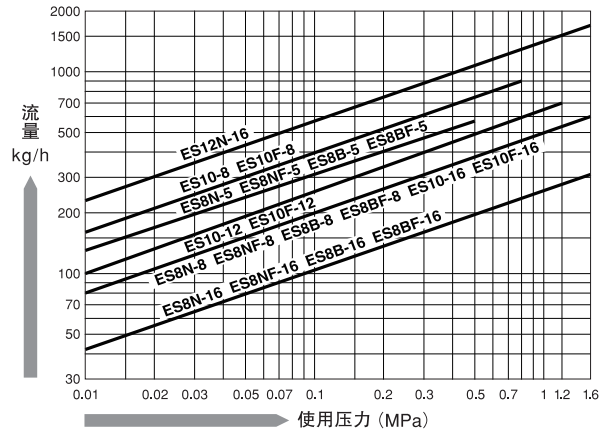

外形尺寸/规格一览

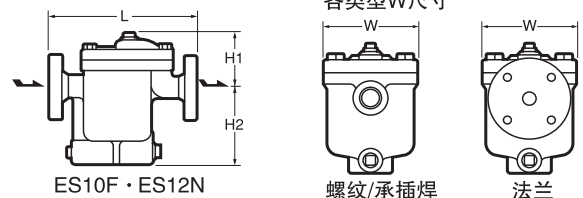
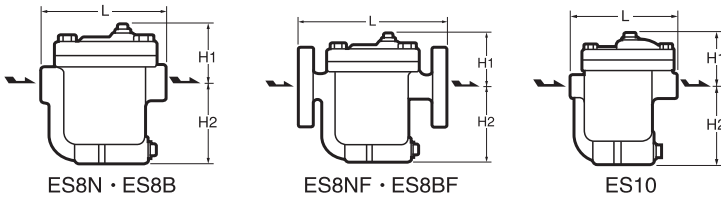
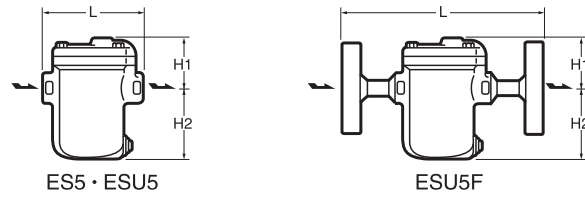

型号	连接		工作压力范围 (MPa)	最高使用温度 (°C)	阀体材质	尺寸(mm)				重量(kg)					
	方式	口径(A)				L	H1	H2	W						
ES5	螺纹 Rc(PT)	15	0.01~0.3·0.7·1.1·1.6	350	球墨铸铁 (FCD450)	103	59	67	75	1.9					
		20				105	57	69		2.0					
		25				109	57	69		2.1					
ESU5	螺纹 Rc(PT)	15	0.01~0.3·0.7·1.1·1.6·2.1	350	不锈钢 (SCS13A)	103	57	69	75	1.9					
		20				105				2.0					
		25				109				2.1					
ESU5F	法兰 (FF, RF)	15				175	57	69	75	3.5					
		20				195				3.7					
		25				215				4.1					
ES8N (ES8B)	螺纹 Rc(PT)	15	0.01~0.5·0.8·1.6	350	球墨铸铁 (FCD450)	130	73	90	100	3.7					
		20				135				3.9					
		25				175				5.3					
ES8NF (ES8BF)	法兰 (FF, RF)	15				195	68	95	100	5.7					
		20				215				6.8					
		25				215				6.8					
ES10	螺纹 Rc(PT)	20·25·32·40	0.01~0.8·1.2·1.6	220	铸铁 (FC250)	190	102	134	120	9.3					
		ES10F				法兰 (FF, RF)				15·20·25	254	102	134	120	12.7
										32·40·50					260
ES12N	法兰 (FF, RF)	15·20·25				0.01~1.6	220	铸铁 (FC250)	270	140	140	120	13.5		
		32·40·50							280				150	130	15.1

◆对应日标、美标、德标、国标等各规格法兰

※压力换算：1MPa=10.197kgf/cm²